

S-energy®

Lubricated Rotary Screw Air Compressors

Constant Speed Drives and Variable Speed Drives

18–30 kW ■ 25–40 hp



SULLAIR®

Always air. Always there.®

ABOUT SULLAIR

For more than 50 years, Sullair has been on the leading edge of compressed air solutions. We were one of the first to execute rotary screw technology in our air compressors. And our machines are famous all over the world for their legendary durability. As the industry moves forward, Sullair will always be at the forefront with quality people, innovative solutions, and air compressors that are built to last.

Sullair was founded in Michigan City, Indiana in 1965, and has since expanded with a broad international network to serve customers in every corner of the globe. Sullair has offices in Chicago and manufacturing facilities in the United States, China and India — all ISO 9001 certified to assure the highest quality standards in manufacturing. In addition, Sullair Suzhou and Shenzhen facilities are ISO9001, ISO14001 and OHSAS 18001 certified.

SULLAIR CAPABILITIES

SULLAIR LEADERSHIP

Since 1965, Sullair has been recognized around the world as an innovator and a leader in rotary screw compression and vacuum technology. For more than 50 years, Sullair has designed and manufactured its own rotors and air end assemblies in Michigan City, Indiana.

The award-winning rotary screw design sets the industry standards and delivers the quality and reliability one expects from a leader.

SULLAIR TECHNOLOGY

Utilizing the most modern technologies, equipment and advanced manufacturing techniques, Sullair designs, manufactures, assembles, and tests the most innovative compressed air and vacuum products in the industry. Sullair products are known around the world for their universally applicable design, outstanding craftsmanship and superior quality.

STATISTICAL PROCESS CONTROL

The Sullair Statistical Process Control (SPC) system monitors rotor quality standards to assure consistent compressor and vacuum performance.

COMMITMENT TO INNOVATION

Underlying leadership at Sullair is a dedication to excellence and a commitment to innovation. Sullair constantly explores new ideas and seeks new ways to meet the industry's need for increasingly energy efficient compressed air and vacuum solutions.

SULLAIR STATIONARY AIR POWER SYSTEMS

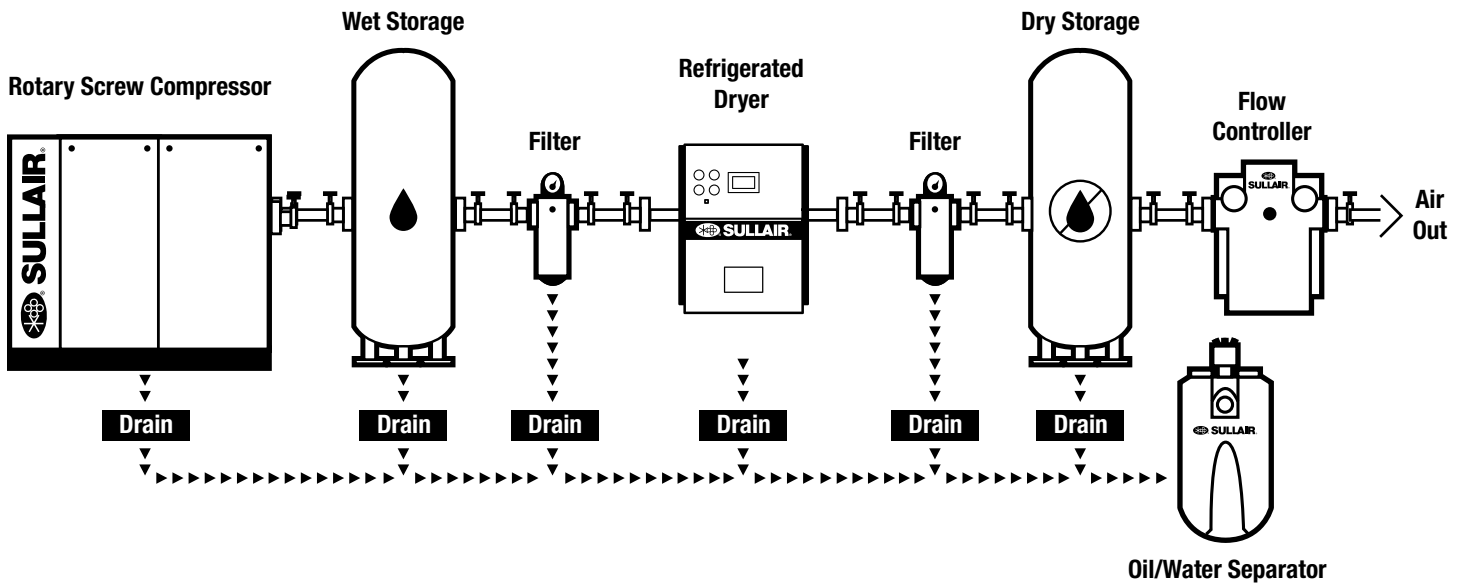

Sullair offers total compressed air systems to help compressed air users reduce energy costs and improve productivity by analyzing, managing and controlling their compressed air systems.

Sullair air systems include: plant air audits, energy efficient products, compressed air system controls, equipment to monitor and manage systems, air distribution products, and after-purchase support.

Each component of the system is carefully matched for capacity and pressure to provide maximum performance and energy efficiency.

The system includes:

- Rotary screw compressor
- Wet storage
- Refrigerated dryer or desiccant dryer
- Filters to meet your requirement
- Dry storage
- Flow controller
- Drains
- Oil/water separator

Sullair Reduces Your Life Cycle Costs

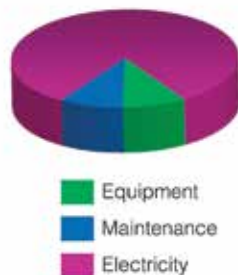

Air Compressor Life Cycle Costs

According to *Best Practices for Compressed Air Systems, Compressed Air Challenge* [Second Edition, 2007] energy costs now represent 82% of the total operating expenses. Energy savings from Sullair S-energy® compressors can significantly reduce life cycle costs.

Sullair S-energy compressors significantly reduce operating and energy costs over the entire compressor life cycle. Contributing to the energy savings are:

- Proven Sullair air end with a low restriction inlet valve
- High efficiency fan
- Low pressure drop air-fluid separation system to prevent energy loss

Sullair designs deliver cost savings for the life of the product. Improved air filtration translates into:

- Extended separator life
- Improved fluid filter life
- Less lubricant contamination

To reduce fluid disposal costs, S-energy compressors are factory-filled with biodegradable Genuine Sullube® 10,000-hour fluid.

- Protects and cleans (no varnish)
- Controls operating temperatures
- Optimal viscosity
- Environmentally friendly
- Reduces fluid loss
- High flash point (505°F/263°C)

FEATURES AND BENEFITS

Sullair compressors provide more performance and efficiency than any other compressors in this horsepower range and set new standards in virtually every category.

Standard Features

- Low restriction inlet valve for better cfm performance
- Low life cycle costs including long-life bearings, rotors, and consumable parts
- Less than 1 ppm fluid carryover
- Excellent motor cooling design characteristics for longer motor life
- Sequencing standard
- NEMA 4 standard
- WS Controller™ standard
- Small footprint
- Quietest in its class, as low as 67 dBA
- 12 unique serviceability features
- Environmental, health, and safety design features
- Genuine Sullube®—10,000 hour, non-varnishing, biodegradable compressor fluid
- Optimalair® air filter provides 10 times better filtration than other filters

Quiet Design

- Air end, motor, and receiver tank are mounted on rubber isolators
- Insulated intake and exhaust louvers
- Low-noise fan

Small Footprint

- More compact than similar compressors on the market
- All maintenance is performed from one side, reducing the amount of clearance and floor space typically required

Options

- Variable Speed Drive
- Cold weather package
- Weather hood
- Total package filtration
- Other motors and starters

S-ENERGY® SERIES COMPRESSORS ARE EASY TO MAINTAIN

Before we designed these compressors, we reviewed every aspect of product development with the customer and the maintenance staff in mind. The result is Sullair reliability in one of the most compact, robust, maintenance-friendly and quietest compressor package available on the market.

Multiple features of the S-energy series revolutionize the compressor's serviceability and provide for a cleaner, safer work environment and cost effective compressor. Standard maintenance can all be performed from this side.



WS Controller™

With the simplified WS microprocessor, there are no complicated menus to manage.

- The graphic display is clear and concise
- Get the critical operations information more easily, including status, temperature, pressure, and load/unload set points
- Use a Windows PC to remotely monitor, upgrade the software, and set up changes
- Built-in sequencing of up to 16 machines



Sullair Motor Features

- Slow speed—1800 rpm
- Cast iron construction
- NEMA design
- Direct coupled/flange mounted
- Most comprehensive warranty in the industry

Environmental Protection Pan

S-energy units feature a fully sealed environmental protection pan to capture spills that may occur during servicing.



Sullair Optimizer™ Air-Fluid Separator

- High-efficiency media
- Lower pressure drop reduces power consumption
- Less than 1 ppm carryover reduces cost of make-up fluid



Fiberglass Fluid Filter

- Coreless, non-metallic design means easy disposal
- 20% more efficient than common cellulose media
- Better filtration lengthens the life of the compressor unit



Sullair Optimalair® Air Filter

- Provides the finest inlet filtration in the industry (.4 micron)
- Keeps fluid clean and extends life of internal components
- Reduces pressure drop during operating life, resulting in energy savings

1. Drive Coupling Element

Easy access through a large opening and a wrap-flex element allows change without disturbing the hubs.

2. Quick Thermostat Change

To change the thermostat, simply thread the old thermostat out, and the new one in.

3. Improved Separator Maintenance

Simply unbolt the lid and lift it off using the handle. No tubing to disconnect, prevents leaking and saves service time.

4+5. Simplified Filter Change

The fluid filter is in an inverted position to minimize lubricant loss during filter changes.



10-year Diamond Warranty

Confirming our rugged design and commitment to customer satisfaction, all new Sullair S-energy® stationary air compressors plus select other models (with discharge pressures up to 150 psig) include the exclusive 10-year Diamond Warranty. The comprehensive warranty covers:

- 10 years on the air end
- 5 years on the motor, VSD, air/fluid receiver, oil cooler and aftercooler

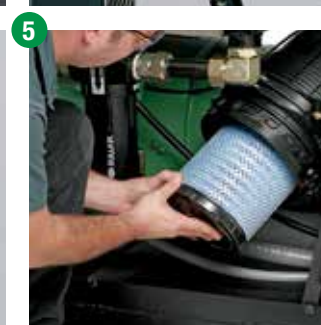
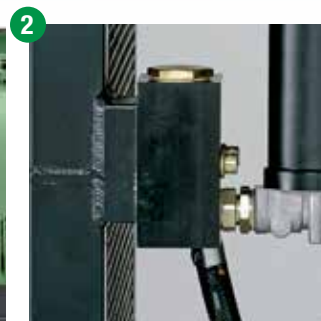

SULLAIR VSD AIR COMPRESSORS

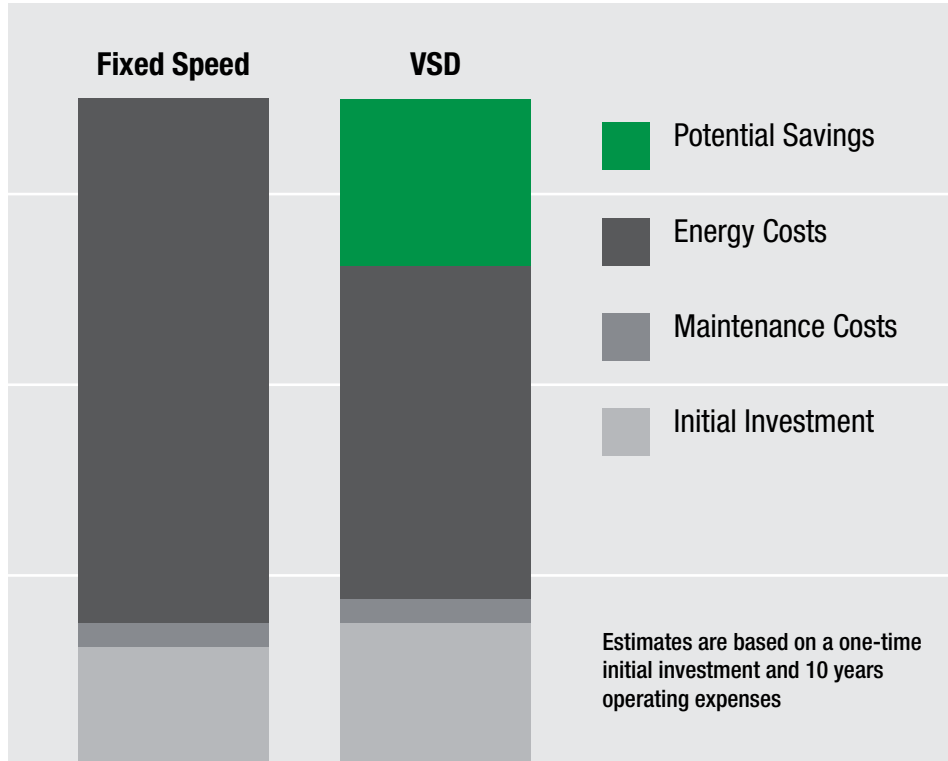

Sullair compressors with VSD provide:

- Excellent energy savings
- Relief from potential peak demand charges
- Possible utility company rebate
- DC link choke with 3% line reactor included (model/voltage specific)
- Stable system pressure
- Consistent product quality
- Reduced system air leaks
- Reduced storage requirements
- Flexibility for future growth
- Low five-year life cycle cost

Your Compressed Air System Can Improve Your Bottom Line

In just ten years, the electrical power cost to operate a standard compressor can be more than six times greater than its purchase price.

Total Compressor Flexibility

Sullair VSD compressors provides the flexibility to vary both capacity and pressure. This flexibility makes it possible to “grow” your air system without adding more compressors.

Variable Speed Drive is the Superior Alternative

The chart above is a representation of nominal control systems for generic comparative purposes. A detailed and accurate comparison of specific compressor models is available from your Sullair representative or authorized distributor.

PART-LOAD PERFORMANCE ASSESSMENT

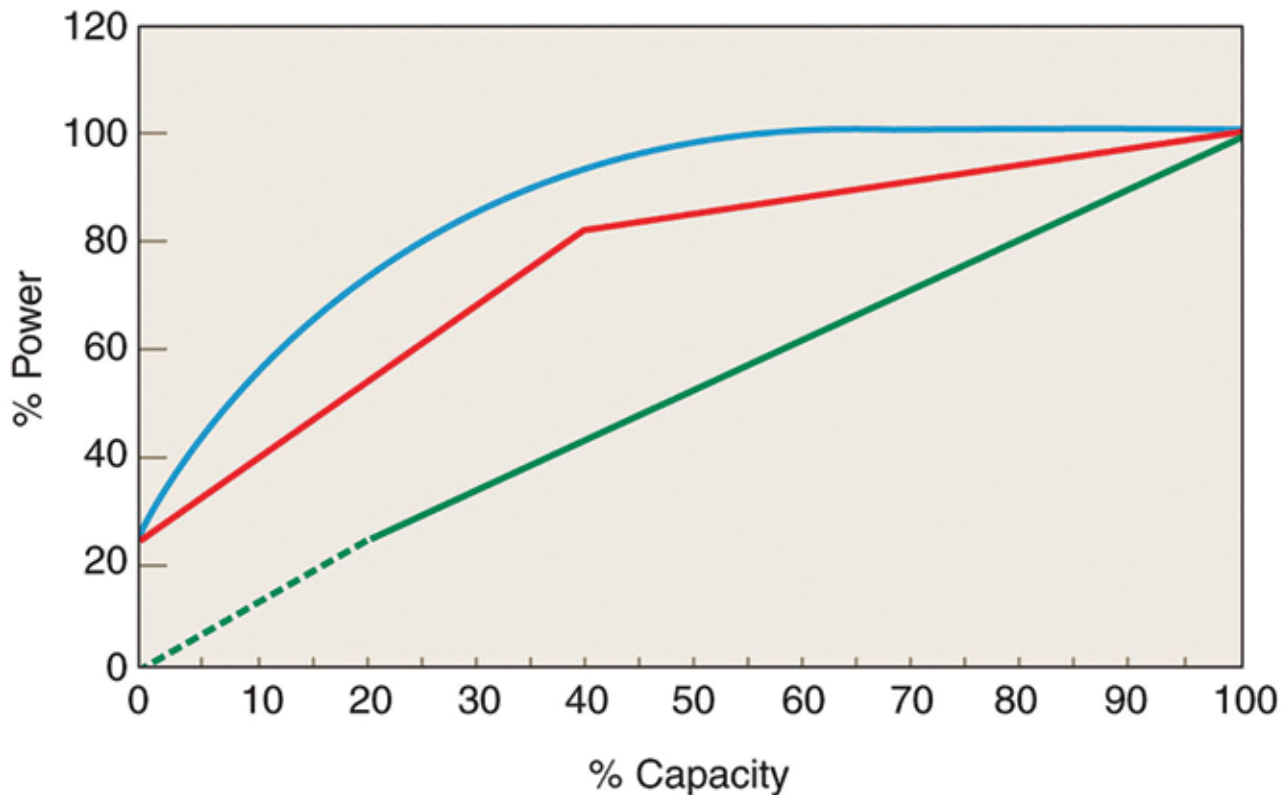

Stable System Pressure Improves the Consistency of Your Process to Reduce Product Rejects

- Lowers air system leaks
- Reduces system storage requirements
- Provides increased energy savings to increase profits

Soft Start is Standard with Unlimited Starts and Stops

- No need for Wye Delta and other soft starters
- No need to control the number of hot or cold starts
- Unlimited starts and stops save electrical costs
- Avoids high electrical current at start-up

VSD Avoids Potential Peak Demand Charges

VSD compressors provide the highest power factor over the entire frequency range, often avoiding utility company penalties.

- Single-Stage Lubricated Load/Unload
(The graph represents one gallon of storage per cfm.)
- Single-Stage Lubricated Inlet Modulation with Blowdown
- Single-Stage Lubricated Variable Speed

CAGI Reference: Compressed Air and Gas Handbook, 6th Edition, pages 221-224.

Standard Compressors

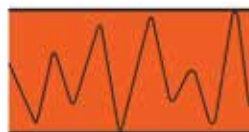

Sullair VSD Compressors



TECHNICAL SPECIFICATIONS

50HZ MOTOR FREQUENCY	MOTOR		FULL-LOAD CAPACITIES **								WEIGHT		DISCHARGE CONNECT	dBA†
			100 PSI acfm	7 bar m³/min	125 PSI acfm	9 bar m³/min	150 PSI acfm	10 bar m³/min	175 PSI acfm	12 bar m³/min	lbs	kg		
Model*	hp	kW												
1800	25	18	109	3.09	101	2.86	90	2.55	84	2.38	1420	644	1½" NPT	67
1800V	25	18	109	3.09	101	2.86	90	2.55	84	2.38	1461	663	1½" NPT	67
2200	30	22	133	3.77	121	3.03	107	3.03	102	2.89	1450	658	1½" NPT	67
2200V	30	22	134	3.79	122	3.45	108	3.05	102	2.89	1491	676	1½" NPT	67
3000	40	30	176	4.98	152	4.30	143	4.05	132	3.74	1615	733	1½" NPT	69
3000V	40	30	176	4.98	152	4.30	143	4.05	132	3.74	1654	750	1½" NPT	69

60HZ MOTOR FREQUENCY	MOTOR		FULL-LOAD CAPACITIES **								WEIGHT		DISCHARGE CONNECT	dBA†
			100 PSI acfm	7 bar m³/min	125 PSI acfm	9 bar m³/min	150 PSI acfm	10 bar m³/min	175 PSI acfm	12 bar m³/min	lbs	kg		
Model*	hp	kW												
1800	25	18	119	3.37	106	3.00	96	2.71	85	2.40	1420	644	1½" NPT	67
1800V	25	18	107	3.05	99	2.80	90	2.54	81	2.30	1461	663	1½" NPT	67
2200	30	22	140	3.96	127	3.59	111	3.14	104	2.94	1450	658	1½" NPT	67
2200V	30	22	138	3.90	125	3.54	115	3.25	105	2.97	1491	676	1½" NPT	67
3000	40	30	-	-	163	4.61	148	4.19	138	3.90	1615	733	1½" NPT	69
3000V	40	30	-	-	163	4.61	150	4.24	140	3.96	1654	750	1½" NPT	69

DIMENSIONS	LENGTH		WIDTH		WEIGHT	
	in	mm	in	mm	lbs	kg
Model*						
1800, 1800V, 2200, 2200V, 3000, 3000V	53.2	1351	31.5	800	1351	532

* Model Variations: V = Variable Speed Drive;

** Capacity per CAGI / PNEUROP PN2CPTC2 (Annex C to ISO 1217) Moisture Drain Connection at ¼" NPT

† dBA at 1 meter

Information and data are subject to change without notice.

For more information, contact your local authorized Sullair distributor.